

VISTA SECURITY SCREEN PREMIUM SERIES PROTECTIVE SECURITY DOOR

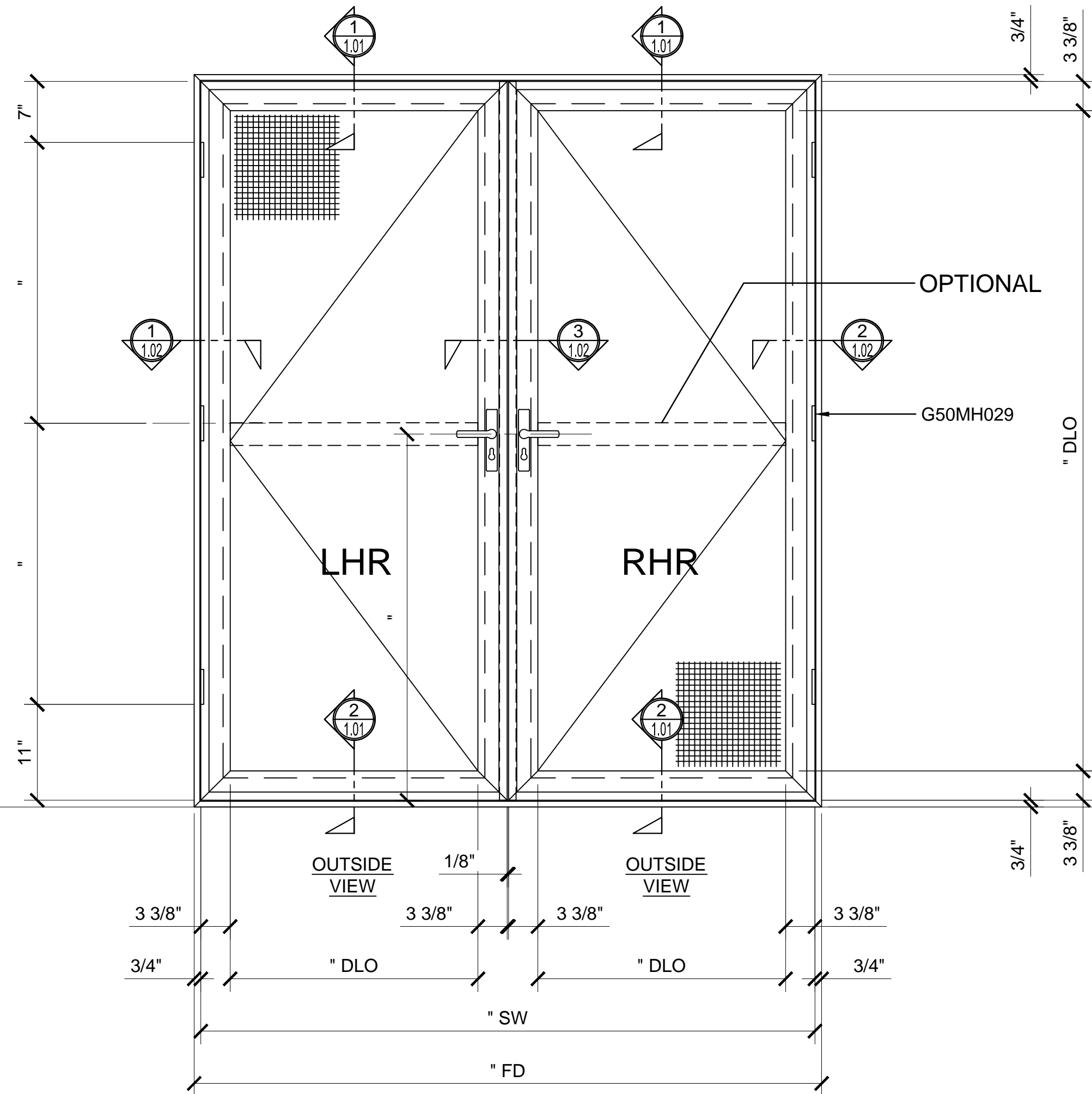

PREMIUM PIVOT FRENCH DOOR - 4 SIDED FRAME

CUSTOM DOOR (HEIGHT) GUIDELINES:
 PREMIUM HINGED 4 SIDED = 21.17" RECOMENDED MIN HEIGHT
 PREMIUM FRENCH 4 SIDED=210.14" RECOMENDED MAX HEIGHT
 CUSTOM DOOR (WIDTH) GUIDELINES:
 PREMIUM HINGED 4 SIDED =13.29" RECOMENDED MIN WIDTH
 PREMIUM FRENCH 4 SIDED = 80.22" RECOMENDED MAXWIDTH

OPTIONS:
 KING LONG PINS HARDWARE - FRENCH DOORS ONLY
 MID-RAIL OPTIONS - VERTICAL AND HORIZONTAL (DETAIL A/1.03)
 INSIDE LEVER OPERATED LOCK
 TRIPLE POINT LOCKS

- COLOR OPTIONS:
- WHITE
 - BLACK
 - BROWN
 - SAHARA BROWN
 - LIGHT GRAY
 - SILVER
 - ALMOND
 - BRONZE
 - SAHARA GRAY
 - CUSTOM

STRUCTURAL DISCLAIMER:
 ALL CUSTOMERS WHO IN ANY WAY UTILIZE THIS PRODUCT ARE SOLELY RESPONSIBLE TO CONSULT A STRUCTURAL ENGINEER TO DETERMINE THE SUITABILITY OF THE PRODUCT FOR THE INTENDED USE AND SITE CONDITIONS. ALL INSTALLERS MUST BE QUALIFIED AND HAVE PROFESSIONAL KNOWLEDGE ABOUT COMPLIANCE WITH LOCAL, STATE AND FEDERAL REGULATIONS, SAFETY FACTORS, AND THE APPROPRIATE CHOICE OF FIXING MATERIAL AND PROCEDURES.

DOOR SWING CHART

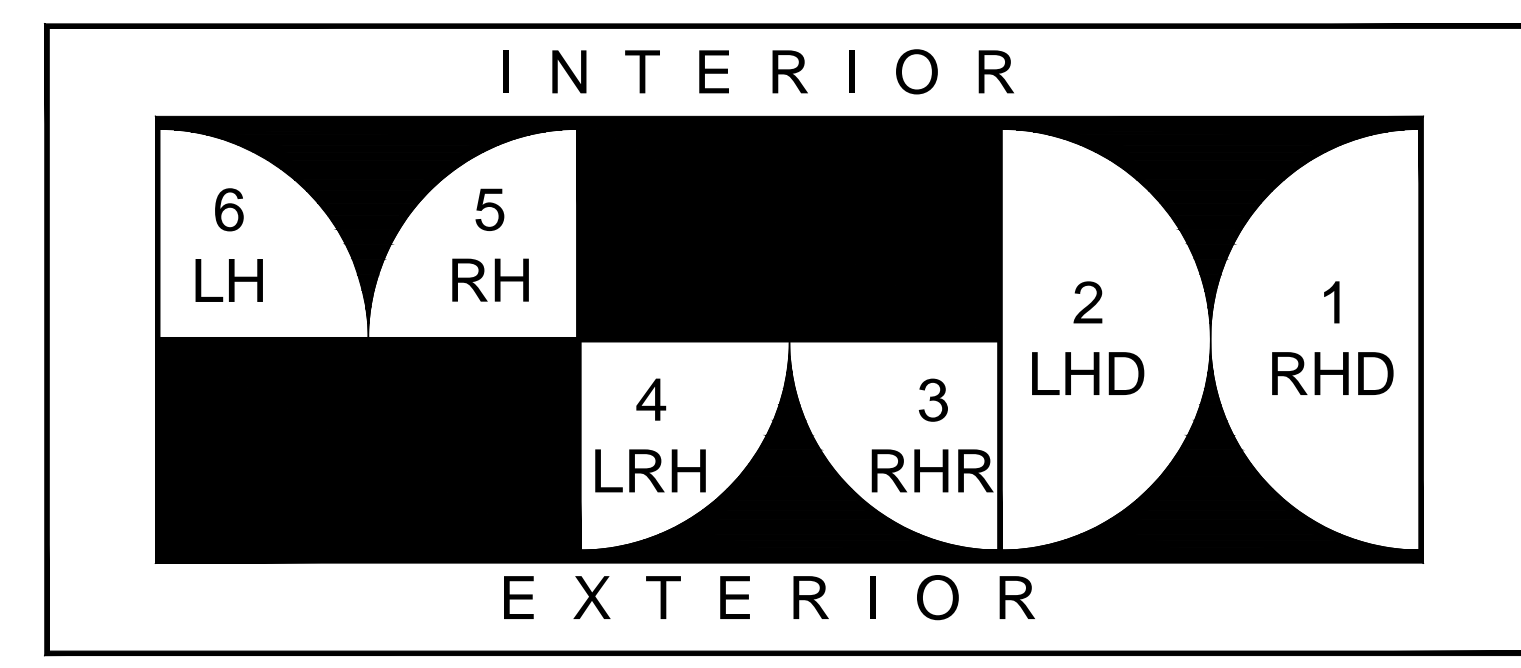

"INDUSTRY STANDARD" DOOR STYLES AND SWINGING DOOR PATTERNS

THERE ARE THREE BASIC DOOR STYLES TYPICALLY REFERRED TO THROUGHOUT THE INDUSTRY APPLICABLE TO THE VISTA SECURITY SCREEN PROTECTIVE SECURITY SCREEN DOOR SYSTEMS. BY IDENTIFYING YOUR BASIC DOOR STYLE AND SWING, IT WILL HELP MAKE CLEAR WHAT YOUR INTENTIONS ARE FOR THE PARTICULAR PROJECT. FOR MORE INFORMATION PLEASE CONTACT US AT (310) 886-1756 OR FAX US AT (310) 327-1180.

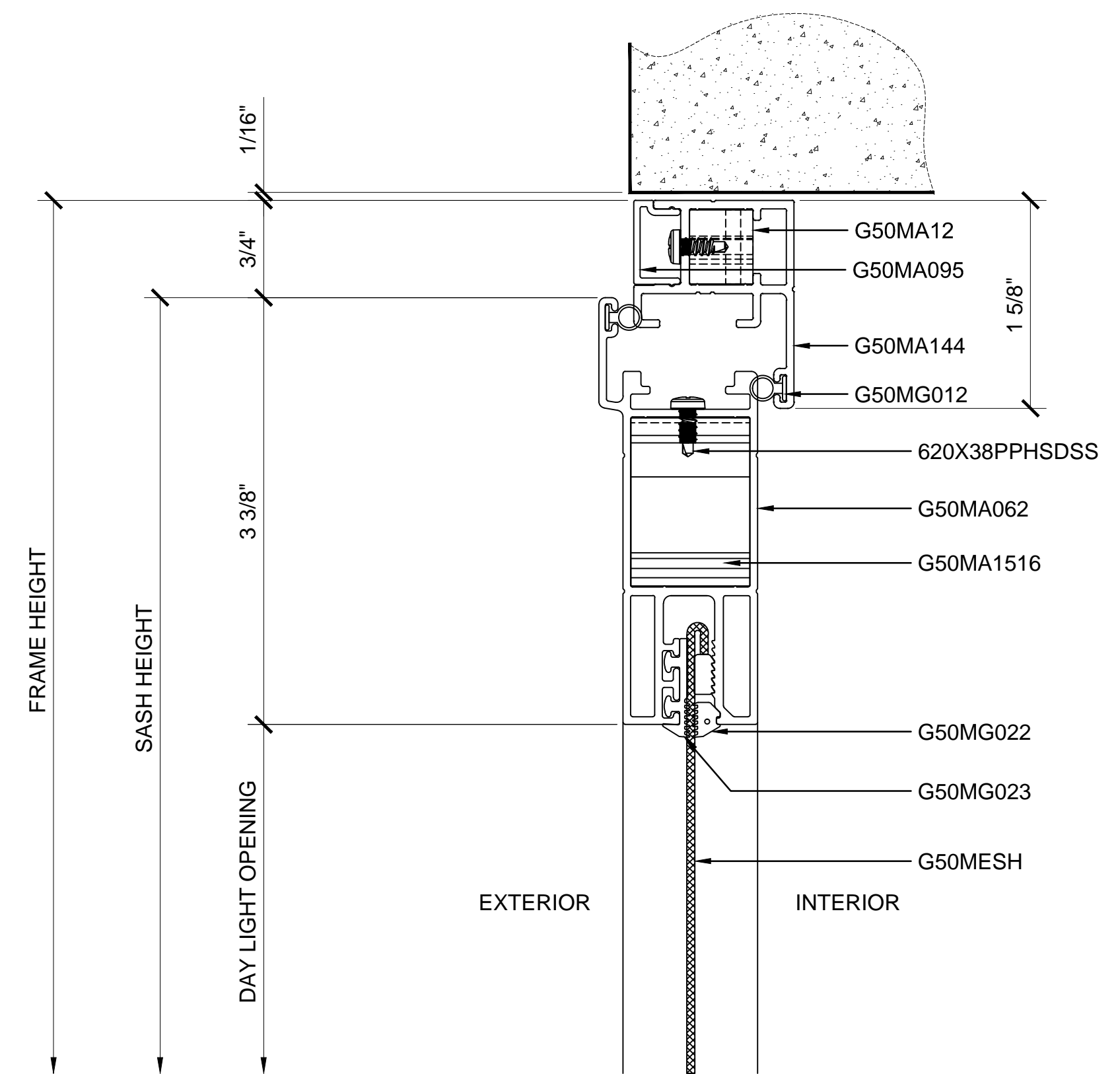

① SECTION DETAIL AT HEAD
 ARCH REF: N/A 1'-0"=1'-0"

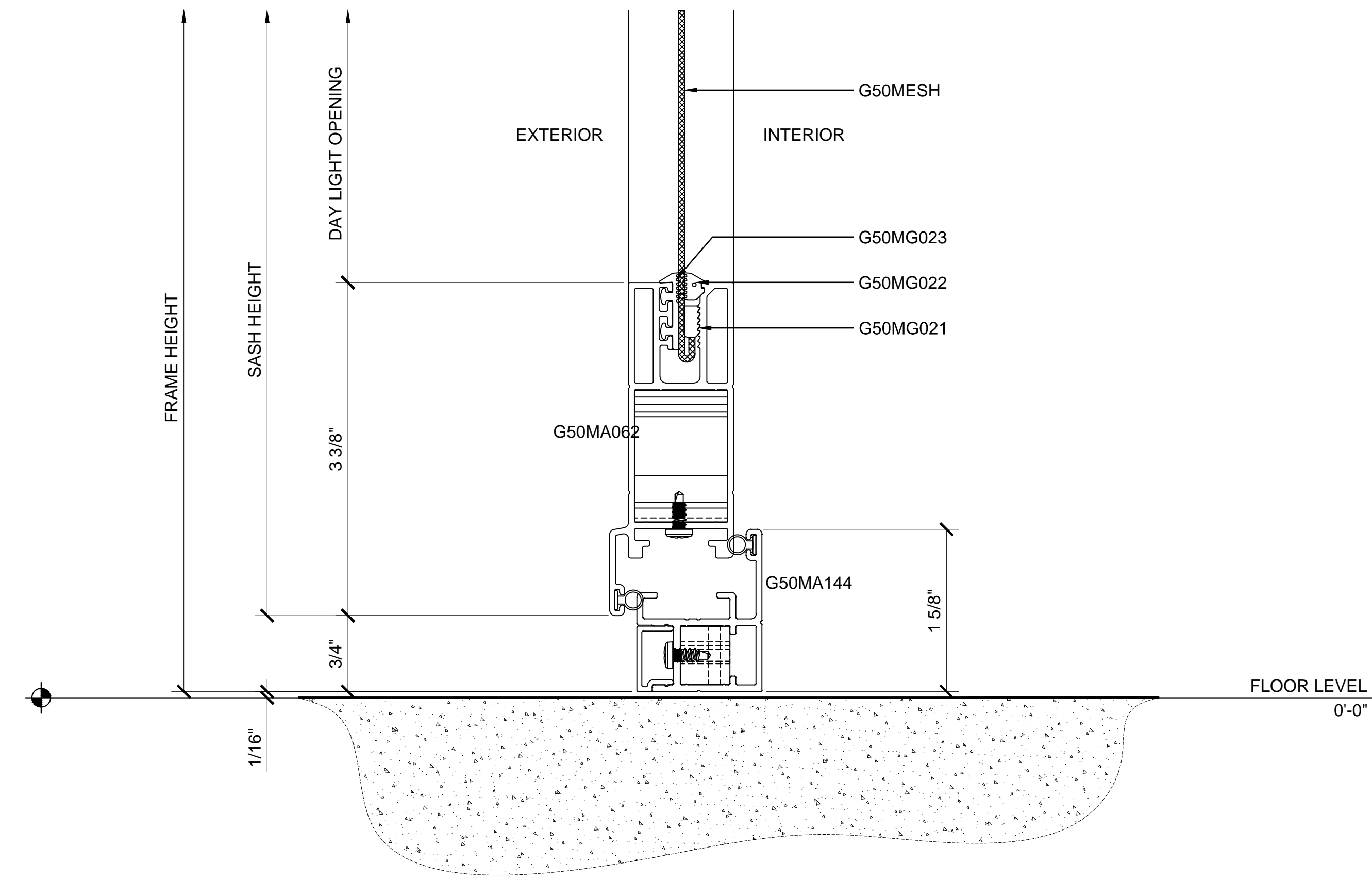

② SECTION DETAIL AT SILL
 ARCH REF: N/A 1'-0"=1'-0"

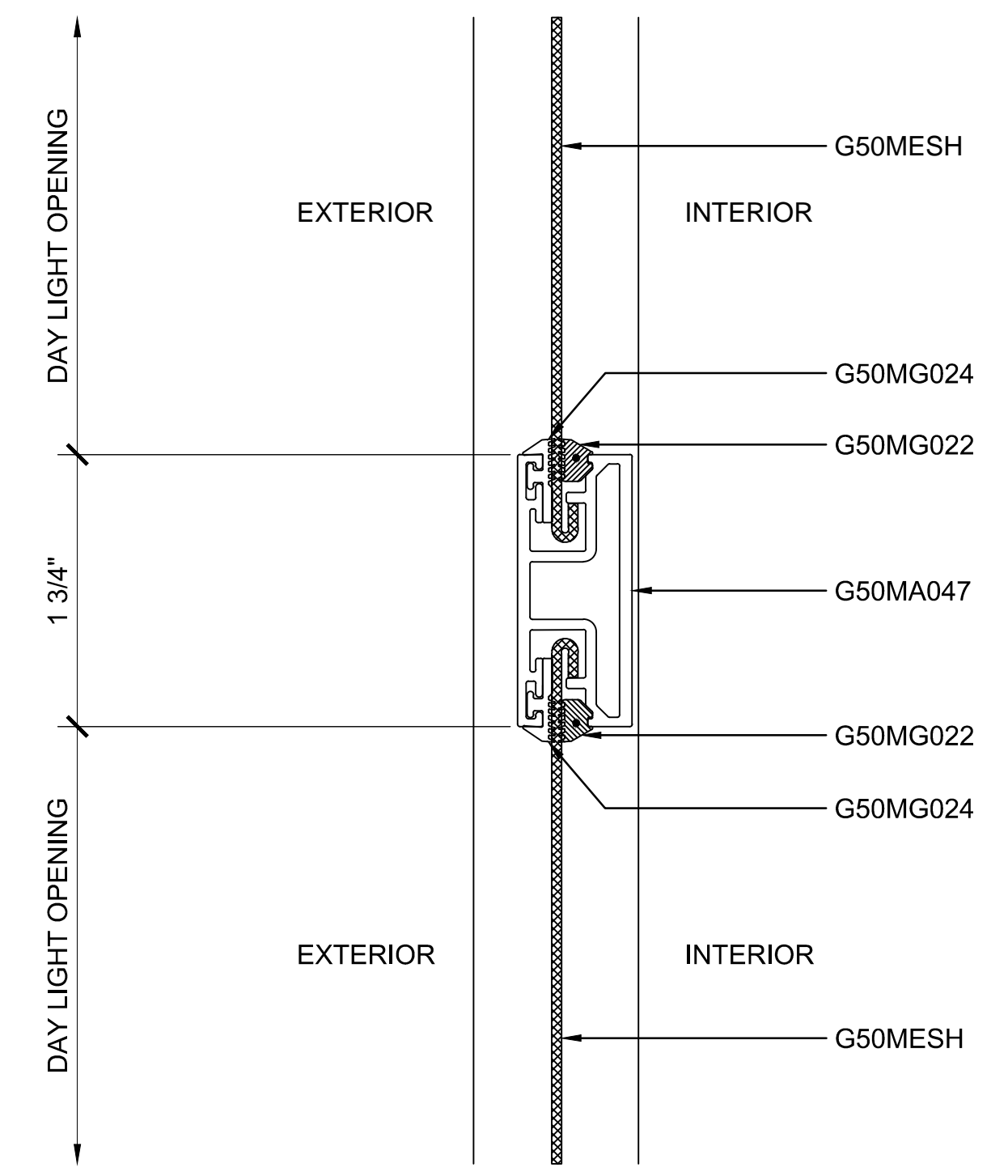

③ SECTION DETAIL AT MIDRAIL - OPTIONAL
 ARCH REF: N/A 1'-0"=1'-0"

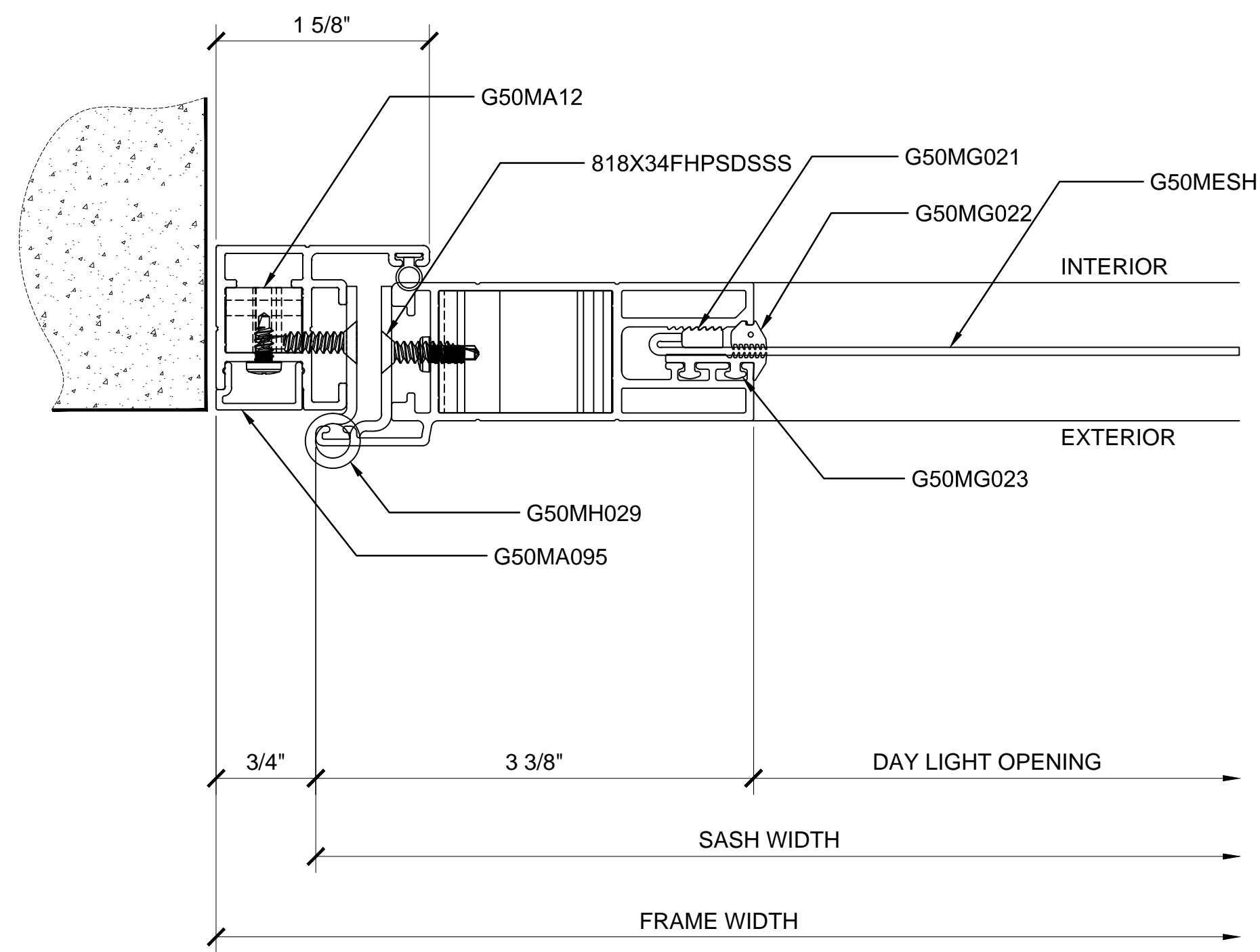

① SECTION DETAIL AT JAMB

ARCH REF: N/A

1'-0"=1'-0"

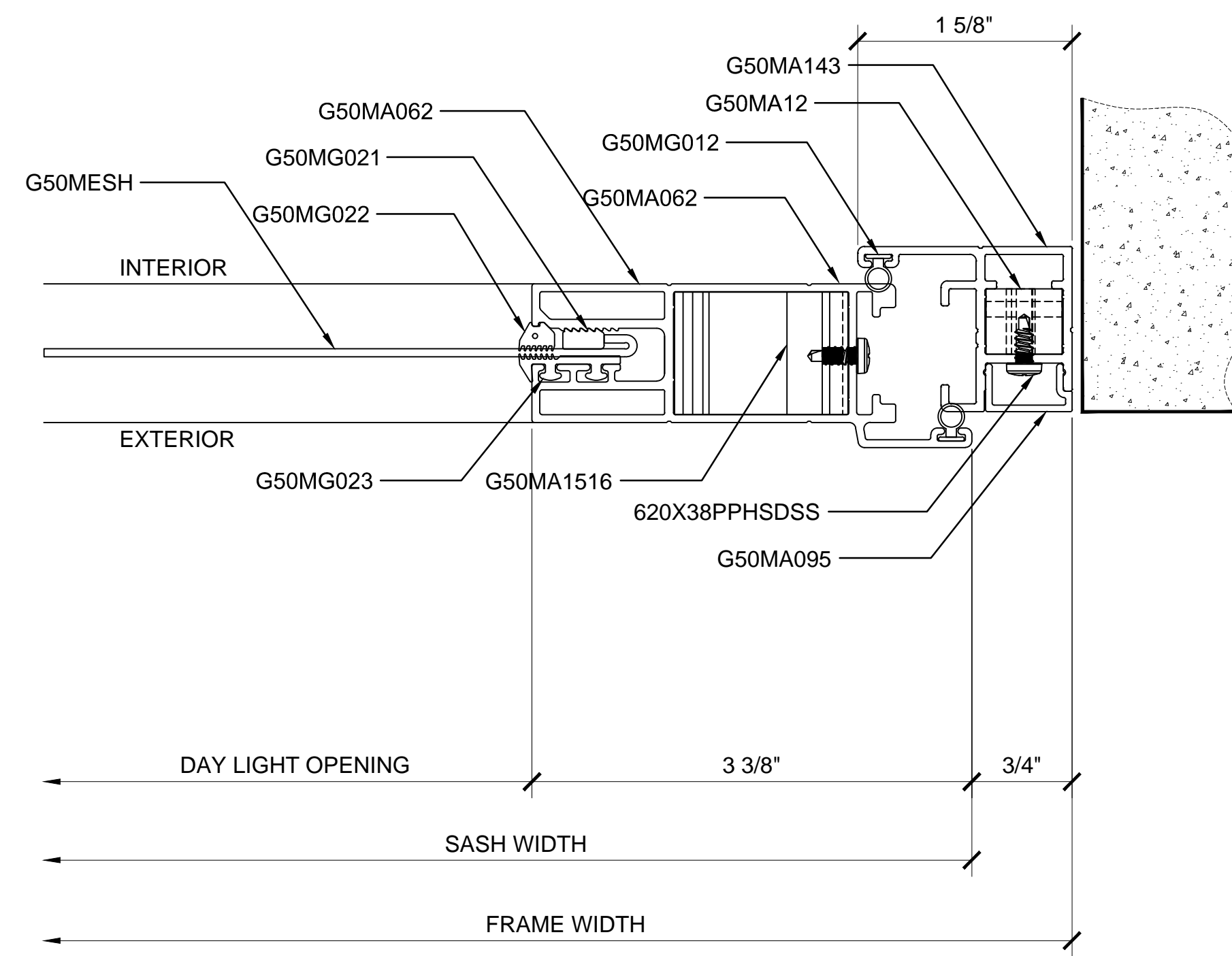

② SECTION DETAIL AT JAMB

ARCH REF: N/A

1'-0"=1'-0"

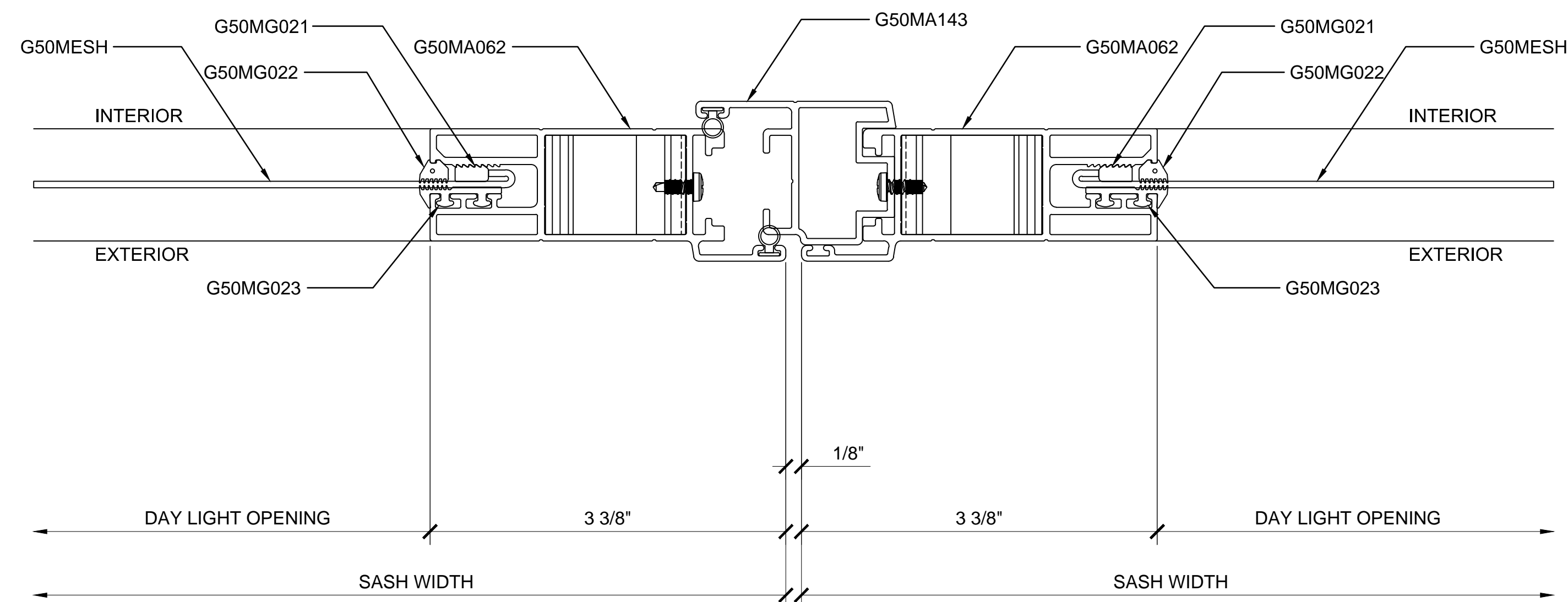

③ SECTION DETAIL AT JAMB

ARCH REF: N/A

1'-0"=1'-0"